

# PRŮMYSLOVÉ HADICE - pro klimatizaci

## Koncovky pro pryžové klimatizační hadice - BURGACLIP

BURGACLIP - samostatné montážní elementy



**8769**



**8768**

modul přípojky	vnitřní prům. hadice [coul]	sponka (plast)		objímka (nerez)	
		index		index	
-06	5/16	BU-8769-06		BU-8768-06	
-08	13/32	BU-8769-08		BU-8768-08	
-10	1/2	BU-8769-10		BU-8768-10	
-12	5/8	BU-8769-12		BU-8768-12	
-14	3/4	BU-8769-14		BU-8768-14	

BURGACLIP - letovací koncovky



**54743**

modul přípojky	modul hadice	rozměr přípojky [coul]	vnitřní prům. hadice [coul]	index
-06	-06	3/8	5/16	BU-54743-06-06-S
-06	-08	3/8	13/32	BU-54743-06-08-S
-08	-08	1/2	13/32	BU-54743-08-08-S
-08	-10	1/2	1/2	BU-54743-08-10-S
-10	-10	5/8	1/2	BU-54743-10-10-S
-10	-12	5/8	5/8	BU-54743-10-12-S
-12	-12	3/4	5/8	BU-54743-12-12-S
-12	-14	3/4	3/4	BU-54743-12-14-S
-12	-16	3/4	7/8	BU-54743-12-16-S
-16	-16	1	7/8	BU-54743-16-16-S

BURGACLIP - spojky



**548753**



**548751**



**548749**

modul hadice	vnitřní prům. hadice [coul]	rozměr ventilu [mm]	spojka		
			index	spojka s ventilem R134 index	spojka 90° index
-06	5/16	16	BU-548753-06-06-S	BU-548753-06-06-HP-S	BU-548749-06-06-S
-08	13/32	16	BU-548753-08-08-S	BU-548753-08-08-HP-S	BU-548749-08-08-S
-10	1/2	13	BU-548753-10-10-S	BU-548753-10-10-LP-S	BU-548749-10-10-S
-12	5/8	13	BU-548753-12-12-S	BU-548753-12-12-LP-S	BU-548749-12-12-S

# PRŮMYSLOVÉ HADICE - pro klimatizaci

## Koncovky pro pryžové klimatizační hadice - BURGACLIP

BURGACLIP - koncovka s vnitřním závitem UNF, trubková



**54704**



**54705**



**54706**

modul přípojky	modul hadice	závit přípojky [coul]	vnitřní prům. hadice [coul]	přímá	45°	90°
				index	index	index
-06	-06	5/8-18	5/16	BU-54704-06-06-S	BU-54705-06-06-S	BU-54706-06-06-S
-06	-08	5/8-18	13/32	BU-54704-06-08-S	-	BU-54706-06-08-S
-08	-06	3/4-16	5/16	BU-54704-08-06-S	BU-54705-08-06-S	-
-08	-08	3/4-16	13/32	BU-54704-08-08-S	BU-54705-08-08-S	BU-54706-08-08-S
-08	-10	3/4-16	1/2	BU-54704-08-10-S	BU-54705-08-10-S	BU-54706-08-10-S
-10	-08	7/8-14	13/32	BU-54704-10-08-S	-	BU-54706-10-08-S
-10	-10	7/8-14	1/2	BU-54704-10-10-S	BU-54705-10-10-S	BU-54706-10-10-S
-10	-12	7/8-14	5/8	BU-54704-10-12-S	BU-54705-10-12-S	BU-54706-10-12-S
-12	-10	1.1/16-14	1/2	BU-54704-12-10-S	-	BU-54706-12-10-S
-12	-12	1.1/16-14	5/8	BU-54704-12-12-S	BU-54705-12-12-S	BU-54706-12-12-S
-12	-14	1.1/16-14	3/4	BU-54704-12-14-S	BU-54705-12-14-S	BU-54706-12-14-S

BURGACLIP - koncovka ke kompresoru s vnitřním závitem UNF



**54707**



**54708**

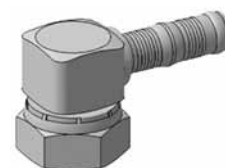

**54709**

modul přípojky	modul hadice	závit přípojky [coul]	vnitřní prům. hadice [coul]	přímá	45°	90°
				index	index	index
-10	-08	1-14	13/32	BU-54707-10-08-S	BU-54708-10-08-S	BU-54709-10-08-S
-10	-10	1-14	1/2	BU-54707-10-10-S	BU-54708-10-10-S	BU-54709-10-10-S
-10	-12	1-14	5/8	BU-54707-10-12-S	BU-54708-10-12-S	BU-54709-10-12-S

BURGACLIP - koncovka ke kompresoru s vnitřním závitem UNF, s ventilem R134



**54733**



**54734**

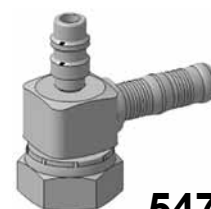

**54735**

modul přípojky	modul hadice	závit přípojky [coul]	vnitřní prům. hadice [coul]	rozměr ventilu [mm]	přímá	45°	90°
					index	index	index
-10	-08	1-14	13/32	16	BU-54733-10-08-HP-S	BU-54734-10-08-HP-S	BU-54735-10-08-HP-S
-10	-10	1-14	1/2	13	BU-54733-10-10-LP-S	BU-54734-10-10-LP-S	BU-54735-10-10-LP-S
-10	-12	1-14	5/8	13	BU-54733-10-12-LP-S	BU-54734-10-12-LP-S	BU-54735-10-12-LP-S

# PRŮMYSLOVÉ HADICE - pro klimatizaci

## Koncovky pro pryžové klimatizační hadice - BURGACLIP

BURGACLIP - T-kusy



**548750**



**548752**

modul hadice 1	vnitřní prům. hadice 1 [coul]	modul hadice 2	vnitřní prům. hadice 2 [coul]	modul hadice 3	vnitřní prům. hadice 3 [coul]	T-kus	Y-kus
						index	index
-06	5/16	-06	5/16	-06	5/16	BU-548750-06-06-06-S	BU-548752-06-06-06S
-08	13/32	-08	13/32	-08	13/32	BU-548750-08-08-08-S	BU-548752-08-08-08S
-10	1/2	-10	1/2	-10	1/2	BU-548750-10-10-10-S	BU-548752-10-10-10S
-12	5/8	-12	5/8	-12	5/8	BU-548750-12-12-12-S	BU-548752-12-12-12S

BURGACLIP - koncovka s vnitřním závitem UNF, trubková, s ventilem R134



**54717**



**54718**



**54719**

modul přípojky	modul hadice	závit přípojky [coul]	vnitřní prům. hadice [coul]	rozměr ventilu [mm]	přímá	45°	90°
					index	index	index
-06	-06	5/8-18	5/16	16	BU-54717-06-06-HP-S*	BU-54718-06-06-HP-S*	BU-54719-06-06-HP-S*
-08	-08	3/4-16	13/32	16	BU-54717-08-08-HP-S*	BU-54718-08-08-HP-S*	BU-54719-08-08-HP-S*
-08	-10	3/4-16	1/2	16	BU-54717-08-10-LP-S	-	-
-10	-10	7/8-14	1/2	13	BU-54717-10-10-HP-S*	BU-54718-10-10-HP-S*	BU-54719-10-10-HP-S*
-10	-10	7/8-14	1/2	13	BU-54717-10-10-LP-S*	BU-54718-10-10-LP-S	BU-54719-10-10-LP-S
-10	-12	7/8-14	5/8	13	BU-54717-10-12-LP-S	BU-54718-10-12-LP-S	BU-54719-10-12-LP-S
-12	-12	1.1/16-14	5/8	13	BU-54717-12-12-LP-S*	BU-54718-12-12-LP-S*	BU-54719-12-12-LP-S*
-12	-14	1.1/16-14	3/4	13	BU-54717-12-14-LP-S	-	-

\* -dostupné také s ventilem R12 (BU-54710 -přímá, BU-54711 -45°, BU-54712 -90°)

# PRŮMYSLOVÉ HADICE - pro klimatizaci

## Koncovky pro pryžové klimatizační hadice - BURGACLIP

BURGACLIP - trubková koncovka bez matice



**54724**



**54725**



**54726**

modul přípojky	modul hadice	rozměr trubky [mm]	vnitřní prům. hadice [coul]	přímá	45°	90°
				index	index	index
-06	-06	8,5	5/16	BU-54724-06-06-S	BU-54725-06-06-S	BU-54726-06-06-S
-08	-06	11,6	5/16	BU-54724-08-06-S		
-08	-08	11,6	13/32	BU-54724-08-08-S	BU-54725-08-08-S	BU-54726-08-08-S
-10	-10	14,4	1/2	BU-54724-10-10-S	-	BU-54726-10-10-S
-10	-12	14,4	5/8	BU-54724-10-12-S	-	-
-12	-10	17,5	1/2	BU-54724-12-10-S	BU-54725-12-10-S	BU-54726-12-10-S
-12	-12	17,5	5/8	BU-54724-12-12-S	BU-54725-12-12-S	BU-54726-12-12-S

BURGACLIP - koncovka s vnitřním závitem UNF, typ SAE, kužel 45°



**54701**



**54702**



**54703**

modul přípojky	modul hadice	závit přípojky [coul]	vnitřní prům. hadice [coul]	přímá	45°	90°
				index	index	index
-04	-06	7/16-20	5/16	BU-54701-04-06-S	BU-54702-04-06-S	BU-54703-04-06-S
-06	-06	5/8-18	5/16	BU-54701-06-06-S	BU-54702-06-06-S	BU-54703-06-06-S
-06	-08	5/8-18	13/32	BU-54701-06-08-S	BU-54702-06-08-S	BU-54703-06-08-S
-08	-06	3/4-16	5/16	BU-54701-08-06-S	BU-54702-08-06-S	BU-54703-08-06-S
-08	-08	3/4-16	13/32	BU-54701-08-08-S	BU-54702-08-08-S	BU-54703-08-08-S
-08	-10	3/4-16	1/2	BU-54701-08-10-S	BU-54702-08-10-S	BU-54703-08-10-S
-10	-08	7/8-14	13/32	BU-54701-10-08-S	BU-54702-10-08-S	BU-54703-10-08-S
-10	-10	7/8-14	1/2	BU-54701-10-10-S	BU-54702-10-10-S	BU-54703-10-10-S
-10	-12	7/8-14	5/8	BU-54701-10-12-S	BU-54702-10-12-S	BU-54703-10-12-S
-12	-12	1.1/16-14	5/8	BU-54701-12-12-S	BU-54702-12-12-S	BU-54703-12-12-S

# PRŮMYSLOVÉ HADICE - pro klimatizaci

## Koncovky pro pryžové klimatizační hadice - BURGACLIP

BURGACLIP - koncovka s vnitřním závitem UNF, trubková



**54740 (54421)**

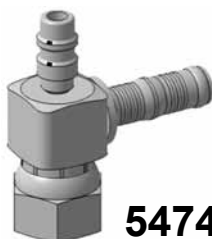

**54742**



**54412 (54422)**

modul přípojky	modul hadice	závit přípojky [coul]	vnitřní prům. hadice [coul]	rozměr ventilu [mm]	holá	s ventilem R134	s ventilem R134
					index	index	index
-06	-06	5/8-18	5/16	16	BU-54740-06-06-S*	BU-54742-06-06-HP-S	BU-54412-06-06-HP-S
-06	-06	5/8-18	5/16	16	BU-54421-06-06-S	-	BU-54422-06-06-HP-S
-08	-08	3/4-16	13/32	16	BU-54740-08-08-S*	BU-54742-08-08-HP-S	BU-54412-08-08-HP-S
-08	-08	3/4-16	13/32	16	BU-54421-08-08-S	-	BU-54422-08-08-HP-S
-10	-10	7/8-14	1/2	13	BU-54740-10-10-S	BU-54742-10-10-LP-S	BU-54412-10-10-LP-S
-10	-10	7/8-14	1/2	13	BU-54421-10-10-S*	-	BU-54422-10-10-LP-S
-12	-12	1.1/16-14	5/8	13	BU-54740-12-12-S	BU-54742-12-12-LP-S	BU-54412-12-12-LP-S

\* -verze „short drop” -s krátkou maticovou částí

BURGACLIP - koncovka pro rychlospojku

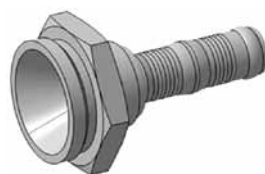

**54747**

modul přípojky	modul hadice	závit přípojky [coul]	vnitřní prům. hadice [coul]	index
-08	-06	7/8-20	5/16	BU-54747-08-06-S
-08	-08	7/8-20	13/32	BU-54747-08-08-S
-12	-10	1.1/4-18	1/2	BU-54747-12-10-S

BURGACLIP - koncovka s vnitřním metrickým závitem, typ DIN 3865, kužel 24°, lehká řada



**54901**



**54910**



**54904**

modul přípojky	modul hadice	závit přípojky [mm]	vnitřní prům. hadice [coul]	přímá	45°	90°
				index	index	index
-22	-14	M30x2	3/4	BU-54901-22-14-S	BU-54910-22-14-S	BU-54904-22-14-S
-22	-16	M30x2	7/8	BU-54901-22-16-S	BU-54910-22-16-S	BU-54904-22-16-S

# PRŮMYSLOVÉ HADICE - pro klimatizaci

## Koncovky pro pryžové klimatizační hadice - BURGACLIP

BURGACLIP - koncovka s vnějším závitem UNF, trubková



**54213**



**54215**



**54214**

modul přípojky	modul hadice	závit přípojky [coul]	vnitřní prům. hadice [coul]	přímá	45°	90°
				index	index	index
-06	-06	5/8-18	5/16	BU-54213-06-06-S	BU-54215-06-06-S	BU-54214-06-06-S
-08	-08	3/4-18	13/32	BU-54213-08-08-S	BU-54215-08-08-S	BU-54214-08-08-S
-10	-10	7/8-18	1/2	BU-54213-10-10-S	BU-54215-10-10-S	BU-54214-10-10-S
-10	-12	7/8-18	5/8	BU-54213-10-12-S	BU-54215-10-12-S	BU-54214-10-12-S
-12	-12	1.1/16-16	5/8	BU-54213-12-12-S	BU-54215-12-12-S	BU-54214-12-12-S

BURGACLIP - koncovka s vnějším závitem UNF, trubková, s ventilem R134



**54217**

modul přípojky	modul hadice	závit přípojky [coul]	vnitřní prům. hadice [coul]	rozměr ventilu	přímá	45°	90°
					index	index	index
-06	-06	5/8-18	5/16	16	-	-	BU-54217-06-06-HP-S
-08	-08	3/4-18	13/32	16	-	-	BU-54217-08-08-HP-S
-10	-10	7/8-18	1/2	13	-	-	BU-54217-10-10-LP-S
-12	-12	1.1/16-16	5/8	13	-	-	BU-54217-12-12-LP-S

BURGACLIP - koncovka s vnějším závitem UNF, se spojkou



**54206**



**54207**



**54208**

modul přípojky	modul hadice	závit přípojky [coul]	vnitřní prům. hadice [coul]	přímá	45°	90°
				index	index	index
-06	-06	5/8-18	5/16	BU-54206-06-06-S	BU-54207-06-06-S	BU-54208-06-06-S
-06	-08	5/8-18	13/32	BU-54206-06-08-S	-	-
-08	-08	3/4-16	13/32	BU-54206-08-08-S	BU-54207-08-08-S	BU-54208-08-08-S
-08	-10	3/4-16	1/2	BU-54206-08-10-S	-	-
-10	-08	7/8-14	13/32	BU-54206-10-08-S	-	-
-10	-10	7/8-14	1/2	BU-54206-10-10-S	BU-54207-10-10-S	BU-54208-10-10-S
-10	-12	7/8-14	5/8	BU-54206-10-12-S	BU-54207-10-12-S	BU-54208-10-12-S
-12	-12	1.1/16-14	5/8	BU-54206-12-12-S	BU-54207-12-12-S	BU-54208-12-12-S

# PRŮMYSLOVÉ HADICE - pro klimatizaci

## Koncovky pro pryžové klimatizační hadice - BURGACLIP

BURGACLIP - koncovka přepážková s vnějším závitem UNF, se spojkou

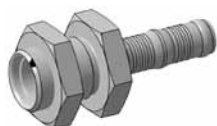

**54758**



**54760**



**54759**

modul přípojky	modul hadice	závit přípojky [coul]	vnitřní prům. hadice [coul]	přímá	45°	90°
				index	index	index
-06	-06	5/8-18	5/16	BU-54758-06-06-S	BU-54760-06-06-S	BU-54759-06-06-S
-08	-08	3/4-16	13/32	BU-54758-08-08-S	BU-54760-08-08-S	BU-54759-08-08-S
-10	-10	7/8-14	1/2	BU-54758-10-10-S	BU-54760-10-10-S	BU-54759-10-10-S
-12	-12	1.1/16-14	5/8	BU-54758-12-12-S	BU-54760-12-12-S	BU-54759-12-12-S

BURGACLIP - koncovka s vnitřním závitem UNF, typ ORFS, ploché těsnění



**54501**



**54502**



**54503**

modul přípojky	modul hadice	závit přípojky [coul]	vnitřní prům. hadice [coul]	přímá	45°	90°
				index	index	index
-04	-06	9/16-18	5/16	BU-54501-04-06-S	BU-54502-04-06-S	BU-54503-04-06-S
-06	-06	11/16-16	5/16	BU-54501-06-06-S	BU-54502-06-06-S	BU-54503-06-06-S
-08	-08	13/16-16	13/32	BU-54501-08-08-S	BU-54502-08-08-S	BU-54503-08-08-S
-10	-10	1-14	1/2	BU-54501-10-10-S	BU-54502-10-10-S	BU-54503-10-10-S
-12	-12	1.3/16-12	5/8	BU-54501-12-12-S	BU-54502-12-12-S	BU-54503-12-12-S

BURGACLIP - koncovka s přírubou BOCK (41,8 mm)



**54754**



**54755**



**54757**

modul přípojky	modul hadice	závit přípojky [coul]	vnitřní prům. hadice [coul]	přímá	45°	90°
				index	index	index
-16	-14	41,8	3/4	BU-54754-16-14-S	BU-54755-16-14-S	BU-54757-16-14-S
-16	-16	41,8	7/8	BU-54754-16-16-S	BU-54755-16-16-S	BU-54757-16-16-S

# PRŮMYSLOVÉ HADICE - pro klimatizaci

## Lis pro klimatizační hadice



Lisy jsou určeny pro armování koncovek na pryžové klimatizační hadice o průměrech 5/16" (8 mm), 13/32" (10,3 mm), 1/2" (12,7 mm), 5/8" (16 mm). Použitím odpovídajících čelistí lze lisovat koncovky na standardní hadice i na hadice se zmenšeným vnějším průměrem. Lisovací hlava umožňuje přetáhnutí přes hadici, což je důležité pro lisování úhlových koncovek.

TNT 250 - šesti čelistový. Lisování dle provedení: ručně pomocí klíče, hydraulickou pumpou s ručním nebo pneumatickým pohonem.

TNT 8 - osmi čelistový. Lisování dle provedení: pomocí elektrické vrtačky, hydraulické pumpy s ručním nebo pneumatickým pohonem.

index	ppopis
PF-TNT250-B	Ruční lis, 6 sad čelistí pro standardní hadice a se zmenšeným vnějším průměrem, mazivo, plastové měřidlo, kufr.
PF-TNT250-P	Ruční lis s ruční hydraulickou pumpou 6 sad čelistí pro standardní hadice a se zmenšeným vnějším průměrem, mazivo, plastové měřidlo, kufr.
PF-APT100	Hydraulická pumpa s pneupohonem (700 bar) - TNT 250.
PF-MPT100	Hydraulická pumpa s ručním pohonem.
PF-UHT100	Hydraulický válec 5,6 T s hadicí 1,8 m (700 bar).
PF-HCT100	Hydraulický válec 5,6 T.
PF-HET100	Hadice 1,8 m (700 bar).
PF-TNT8-MPT100MOSI	Ruční lis s hydraulickou pumpou poháněnou vrtačkou, 6 sady čelistí pro standardní hadice a se zmenšeným vnějším průměrem, kufr.
PF-TNT8-MPT10032SE	Ruční lis s ruční hydraulickou pumpou, 6 sad čelistí pro standardní hadice a se zmenšeným vnějším průměrem, kufr.
PF-TNT8-UHTM	Ruční lis s hydraulickým válcem a hadicí 1,8 m, 6 sad čelistí pro standardní hadice a se zmenšeným vnějším průměrem, kufr.
PF-APT100-TNT8	Hydraulická pumpa s pneupohonem (300 bar) - TNT 8.



PF-TNT250-P



PF-APT100



PF-TNT8-MPT100MOSI



PF-TNT8-MPT10032SE



# PRŮMYSLOVÉ HADICE - pro klimatizaci

## Koncovky pro pryžové klimatizační hadice

Koncovka s vnitřním závitem UNF, typ SAE, kužel 45°

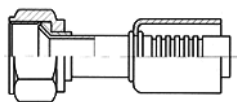

**52701**

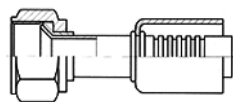

**53701**

modul přípojky	modul hadice	závit přípojky [coul]	vnitř. prům. hadice [coul]	rozměr ventilu	lisovaná	
					index	index
-04	-06	7/16-20	5/16	-	BU-52701-04-06-S	BU-53701-04-06-S
-06	-06	5/8-18	5/16	-	BU-52701-06-06-S	BU-53701-06-06-S
-06	-08	5/8-18	13/32	-	BU-52701-06-08-S	BU-53701-06-08-S
-08	-06	3/4-16	5/16	-	BU-52701-08-06-S	BU-53701-08-06-S
-08	-08	3/4-16	13/32	-	BU-52701-08-08-S	BU-53701-08-08-S
-08	-10	3/4-16	1/2	-	BU-52701-08-10-S	BU-53701-08-10-S
-10	-08	7/8-14	13/32	-	BU-52701-10-08-S	-
-10	-10	7/8-14	1/2	-	BU-52701-10-10-S	BU-53701-10-10-S
-10	-12	7/8-14	5/8	-	BU-52701-10-12-S	-
-12	-12	1.1/16-14	5/8	-	BU-52701-12-12-S	BU-53701-12-12-S

Koncovka 45° s vnitřním závitem UNF, typ SAE, kužel 45°

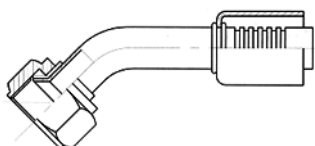

**52702**

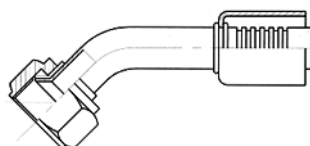

**53702**

modul přípojky	modul hadice	závit přípojky [coul]	vnitř. prům. hadice [coul]	rozměr ventilu	lisovaná	
					index	index
-04	-06	7/16-20	5/16	-	BU-52702-04-06-S	BU-53702-04-06-S
-06	-06	5/8-18	5/16	-	BU-52702-06-06-S	BU-53702-06-06-S
-06	-08	5/8-18	13/32	-	BU-52702-06-08-S	-
-08	-06	3/4-16	5/16	-	BU-52702-08-06-S	BU-53702-08-06-S
-08	-08	3/4-16	13/32	-	BU-52702-08-08-S	BU-53702-08-08-S
-08	-10	3/4-16	1/2	-	BU-52702-08-10-S	BU-53702-08-10-S
-10	-08	7/8-14	13/32	-	BU-52702-10-08-S	-
-10	-10	7/8-14	1/2	-	BU-52702-10-10-S	BU-53702-10-10-S
-10	-12	7/8-14	5/8	-	BU-52702-10-12-S	-
-12	-12	1.1/16-14	5/8	-	BU-52702-12-12-S	BU-53702-12-12-S

# PRŮMYSLOVÉ HADICE - pro klimatizaci

## Koncovky pro pryžové klimatizační hadice

Koncovka 90° s vnitřním závitem UNF, typ SAE, kužel 45°

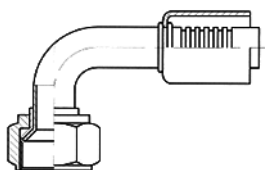

**52703**

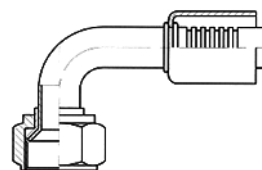

**53703**

modul přípojky	modul hadice	závit přípojky [coul]	vnitř. prům. hadice [coul]	rozměr ventilu	lisovaná	
					index	lisovaná - hadice LW index
-04	-06	7/16-20	5/16	-	BU-52703-04-06-S	-
-06	-06	5/8-18	5/16	-	BU-52703-06-06-S	BU-53703-06-06-S
-06	-08	5/8-18	13/32	-	BU-52703-06-08-S	-
-08	-06	3/4-16	5/16	-	BU-52703-08-06-S	-
-08	-08	3/4-16	13/32	-	BU-52703-08-08-S	BU-53703-08-08-S
-08	-10	3/4-16	1/2	-	BU-52703-08-10-S	-
-10	-08	7/8-14	13/32	-	BU-52703-10-08-S	-
-10	-10	7/8-14	1/2	-	BU-52703-10-10-S	BU-53703-10-10-S
-10	-12	7/8-14	5/8	-	BU-52703-10-12-S	-
-12	-12	1.1/16-14	5/8	-	BU-52703-12-12-S	BU-53703-12-12-S

Koncovka s vnitřním závitem UNF, trubková

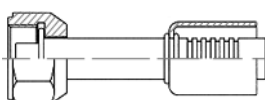

**52704**

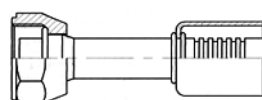

**53704**

modul přípojky	modul hadice	závit přípojky [coul]	vnitř. prům. hadice [coul]	rozměr ventilu	lisovaná	
					index	lisovaná - hadice LW index
-06	-06	5/8-18	5/16	-	BU-52704-06-06-S	BU-53704-06-06-S
-06	-08	5/8-18	13/32	-	BU-52704-06-08-S	BU-53704-06-08-S
-08	-06	3/4-16	5/16	-	BU-52704-08-06-S	BU-53704-08-06-S
-08	-08	3/4-16	13/32	-	BU-52704-08-08-S	BU-53704-08-08-S
-08	-10	3/4-16	1/2	-	BU-52704-08-10-S	BU-53704-08-10-S
-10	-08	7/8-14	13/32	-	BU-52704-10-08-S	BU-53704-10-08-S
-10	-10	7/8-14	1/2	-	BU-52704-10-10-S	BU-53704-10-10-S
-10	-12	7/8-14	5/8	-	BU-52704-10-12-S	BU-53704-10-12-S
-12	-10	1.1/16-14	1/2	-	BU-52704-12-10-S	BU-53704-12-10-S
-12	-12	1.1/16-14	5/8	-	BU-52704-12-12-S	BU-53704-12-12-S
-12	-14	1.1/16-14	3/4	-	BU-52704-12-14-S	-

# PRŮMYSLOVÉ HADICE - pro klimatizaci

## Koncovky pro pryžové klimatizační hadice

Koncovka 45° s vnitřním závitem UNF, trubková

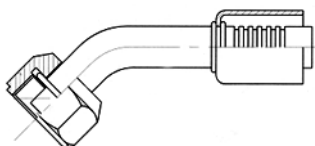

**52705**

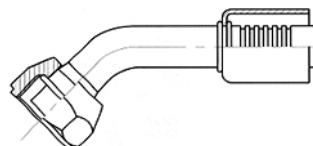

**53705**

modul přípojky	modul hadice	závit přípojky [coul]	vnitř. prům. hadice [coul]	rozměr ventilu	lisovaná	
					index	lisovaná - hadice LW index
-06	-06	5/8-18	5/16	-	BU-52705-06-06-S	BU-53705-06-06-S
-06	-08	5/8-18	13/32	-	BU-52705-06-08-S	-
-08	-08	3/4-16	13/32	-	BU-52705-08-08-S	BU-53705-08-08-S
-08	-10	3/4-16	1/2	-	BU-52705-08-10-S	BU-53705-08-10-S
-10	-10	7/8-14	1/2	-	BU-52705-10-10-S	BU-53705-10-10-S
-10	-12	7/8-14	5/8	-	BU-52705-10-12-S	BU-53705-10-12-S
-10	-14	7/8-14	3/4	-	BU-52705-10-14-S	-
-12	-12	1.1/16-14	5/8	-	BU-52705-12-12-S	BU-53705-12-12-S
-12	-14	1.1/16-14	3/4	-	BU-52705-12-14-S	-

Koncovka 90° s vnitřním závitem UNF, trubková

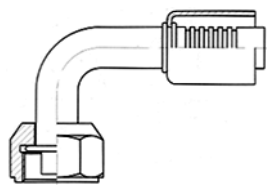

**52706**

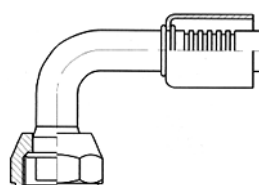

**53706**

modul přípojky	modul hadice	závit přípojky [coul]	vnitř. prům. hadice [coul]	rozměr ventilu	lisovaná	
					index	lisovaná - hadice LW index
-06	-06	5/8-18	5/16	-	BU-52706-06-06-S	BU-53706-06-06-S
-06	-08	5/8-18	13/32	-	BU-52706-06-08-S	BU-53706-06-08-S
-08	-08	3/4-16	13/32	-	BU-52706-08-08-S	BU-53706-08-08-S
-08	-10	3/4-16	1/2	-	BU-52706-08-10-S	BU-53706-08-10-S
-10	-08	7/8-14	13/32	-	BU-52706-10-08-S	BU-53706-10-08-S
-10	-10	7/8-14	1/2	-	BU-52706-10-10-S	BU-53706-10-10-S
-10	-12	7/8-14	5/8	-	BU-52706-10-12-S	BU-53706-10-12-S
-10	-14	7/8-14	3/4	-	BU-52706-10-14-S	-
-12	-10	1.1/16-14	1/2	-	BU-52706-12-10-S	BU-53706-12-10-S
-12	-12	1.1/16-14	5/8	-	BU-52706-12-12-S	BU-53706-12-12-S
-12	-14	1.1/16-14	3/4	-	BU-52706-12-14-S	-

# PRŮMYSLOVÉ HADICE - pro klimatizaci

## Koncovky pro pryžové klimatizační hadice

Koncovka 180° s vnitřním závitem UNF, trubková

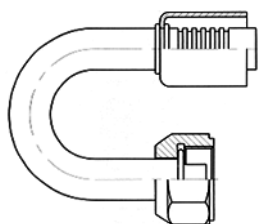

**52771**

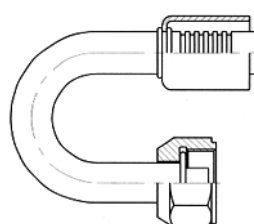

**53771**

modul přípojky	modul hadice	závit přípojky [coul]	vnitř. prům. hadice [coul]	rozměr ventilu	lisovaná	
					index	lisovaná - hadice LW index
-06	-06	5/8-18	5/16	-	BU-52771-06-06-S	BU-53771-06-06-S
-08	-08	3/4-16	13/32	-	BU-52771-08-08-S	BU-53771-08-08-S
-10	-10	7/8-14	1/2	-	BU-52771-10-10-S	BU-53771-10-10-S
-12	-12	1.1/16-14	5/8	-	BU-52771-12-12-S	BU-53771-12-12-S

Koncovka s vnitřním závitem UNF, trubková, s ventilem R12

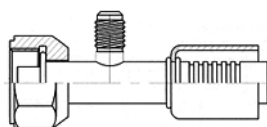

**52710**

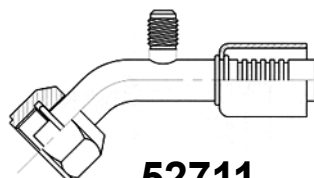

**52711**

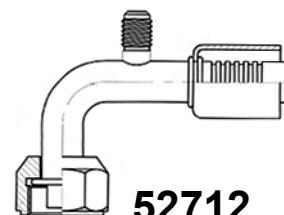

**52712**

modul přípojky	modul hadice	závit přípojky [coul]	vnitř. prům. hadice [coul]	rozměr ventilu	lisovaná		
					index	lisovaná 45° index	lisovaná 90° index
-06	-06	5/8-18	5/16	1/4	BU-52710-06-06-S	BU-52711-06-06-S	BU-52712-06-06-S
-08	-08	3/4-16	13/32	1/4	BU-52710-08-08-S	BU-52711-08-08-S	BU-52712-08-08-S
-10	-10	7/8-14	1/2	1/4	BU-52710-10-10-S	BU-52711-10-10-S	BU-52712-10-10-S
-12	-12	1.1/16-14	5/8	1/4	BU-52710-12-12-S	BU-52711-12-12-S	BU-52712-12-12-S

Koncovka s vnitřním závitem UNF, trubková, s ventilem R134

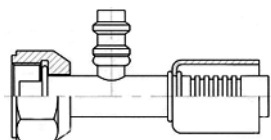

**52717**

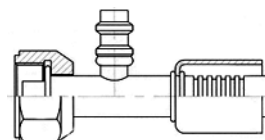

**53717**

modul přípojky	modul hadice	závit přípojky [coul]	vnitř. prům. hadice [coul]	rozměr ventilu [mm]	lisovaná	
					index	lisovaná - hadice LW index
-06	-06	5/8-18	5/16	16	BU-52717-06-06-HP-S	BU-53717-06-06-HP-S
-08	-08	3/4-16	13/32	16	BU-52717-08-08-HP-S	BU-53717-08-08-HP-S
-08	-10	3/4-16	1/2	16	BU-52717-08-10-LP-S	BU-53717-08-10-LP-S
-10	-10	7/8-14	1/2	13	BU-52717-10-10-LP-S	BU-53717-10-10-LP-S
-10	-12	7/8-14	5/8	13	BU-52717-10-12-LP-S	BU-53717-10-12-LP-S
-12	-12	1.1/16-14	5/8	13	BU-52717-12-12-LP-S	BU-53717-12-12-LP-S
-12	-14	1.1/16-14	3/4	13	BU-52717-12-14-LP-S	BU-53717-12-14-LP-S

# PRŮMYSLOVÉ HADICE - pro klimatizaci

## Koncovky pro pryžové klimatizační hadice

Koncovka 45° s vnitřním závitem UNF, trubková, s ventilem R134

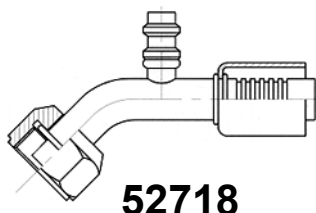

**52718**

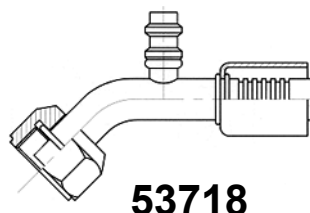

**53718**

modul přípojky	modul hadice	závit přípojky [coul]	vnitř. prům. hadice [coul]	rozměr ventilu [mm]	lisovaná	
					index	lisovaná - hadice LW index
-06	-06	5/8-18	5/16	16	BU-52718-06-06-HP-S	BU-53718-06-06-HP-S
-08	-08	3/4-16	13/32	16	BU-52718-08-08-HP-S	BU-53718-08-08-HP-S
-10	-10	7/8-14	1/2	13	BU-52718-10-10-LP-S	BU-53718-10-10-LP-S
-10	-12	7/8-14	5/8	13	BU-52718-10-12-LP-S	BU-53718-10-12-LP-S
-12	-12	1.1/16-14	5/8	13	BU-52718-12-12-LP-S	BU-53718-12-12-LP-S

Koncovka 90° s vnitřním závitem UNF, trubková, s ventilem R134

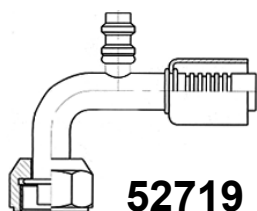

**52719**

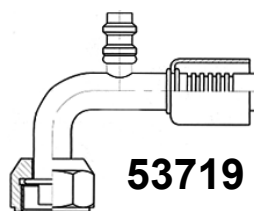

**53719**

modul přípojky	modul hadice	závit přípojky [coul]	vnitř. prům. hadice [coul]	rozměr ventilu [mm]	lisovaná	
					index	lisovaná - hadice LW index
-06	-06	5/8-18	5/16	16	BU-52719-06-06-HP-S	BU-53719-06-06-HP-S
-08	-08	3/4-16	13/32	16	BU-52719-08-08-HP-S	BU-53719-08-08-HP-S
-10	-10	7/8-14	1/2	13	BU-52719-10-10-LP-S	BU-53719-10-10-LP-S
-10	-12	7/8-14	5/8	13	BU-52719-10-12-LP-S	BU-53719-10-12-LP-S
-12	-12	1.1/16-14	5/8	13	BU-52719-12-12-LP-S	BU-53719-12-12-LP-S

Koncovka 90° COMPACT s vnitřním závitem UNF, trubková

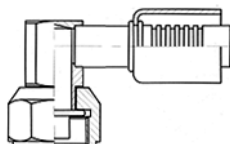

**52740**

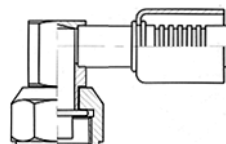

**53740**

modul přípojky	modul hadice	závit přípojky [coul]	vnitř. prům. hadice [coul]	rozměr ventilu	lisovaná	
					index	lisovaná - hadice LW index
-06	-06	5/8-18	5/16	-	BU-52740-06-06-S	BU-53740-06-06-S
-08	-08	3/4-16	13/32	-	BU-52740-08-08-S	BU-53740-08-08-S
-10	-10	7/8-14	1/2	-	BU-52740-10-10-S	BU-53740-10-10-S
-12	-12	1.1/16-14	5/8	-	BU-52740-12-12-S	BU-53740-12-12-S

# PRŮMYSLOVÉ HADICE - pro klimatizaci

## Koncovky pro pryžové klimatizační hadice

Koncovka 90° COMPACT s vnitřním závitem UNF, trubková, s ventilem R134

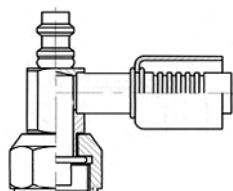

**52742**

modul přípojky	modul hadice	závit přípojky [coul]	vnitř. prům. hadice [coul]	rozměr ventilu [mm]	lisovaná	
					index	lisovaná - hadice LW index
-06	-06	5/8-18	5/16	16	BU-52742-06-06-HP-S	-
-08	-08	3/4-16	13/32	16	BU-52742-08-08-HP-S	-
-10	-10	7/8-14	1/2	13	BU-52742-10-10-LP-S	-
-12	-12	1.1/16-14	5/8	13	BU-52742-12-12-LP-S	-

Trubková koncovka bez matice

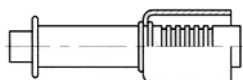

**52724**

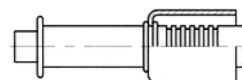

**53724**

modul přípojky	modul hadice	rozměr trubky	vnitř. prům. hadice [coul]	rozměr ventilu	lisovaná	
					index	lisovaná - hadice LW index
-06	-06	8,5	5/16	-	BU-52724-06-06-S	BU-53724-06-06-S
-06	-08	8,5	13/32	-	BU-52724-06-08-S	BU-53724-06-08-S
-08	-06	11,6	5/16	-	BU-52724-08-06-S	BU-53724-08-06-S
-08	-08	11,6	13/32	-	BU-52724-08-08-S	BU-53724-08-08-S
-10	-10	14,4	1/2	-	BU-52724-10-10-S	BU-53724-10-10-S
-10	-12	14,4	5/8	-	BU-52724-10-12-S	BU-53724-10-12-S
-12	-10	17,5	1/2	-	BU-52724-12-10-S	BU-53724-12-10-S
-12	-12	17,5	5/8	-	BU-52724-12-12-S	BU-53724-12-12-S

Trubková koncovka 45° bez matice

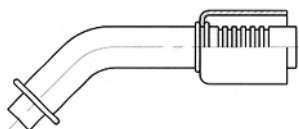

**52725**

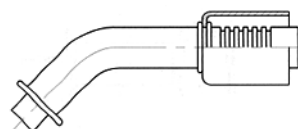

**53725**

modul přípojky	modul hadice	rozměr trubky	vnitř. prům. hadice [coul]	rozměr ventilu	lisovaná	
					index	lisovaná - hadice LW index
-06	-06	8,5	5/16	-	BU-52725-06-06-S	BU-53725-06-06-S
-08	-08	11,6	13/32	-	BU-52725-08-08-S	BU-53725-08-08-S
-10	-10	14,4	1/2	-	BU-52725-10-10-S	BU-53725-10-10-S
-12	-10	17,5	1/2	-	BU-52725-12-10-S	BU-53725-12-10-S
-12	-12	17,5	5/8	-	BU-52725-12-12-S	BU-53725-12-12-S

# PRŮMYSLOVÉ HADICE - pro klimatizaci

## Koncovky pro pryžové klimatizační hadice

Trubková koncovka 90° bez matice

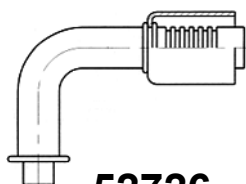

**52726**

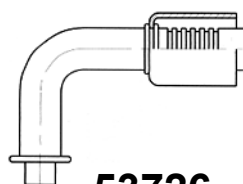

**53726**

modul přípojky	modul hadice	rozměr trubky	vnitř. prům. hadice [cou]	rozměr ventilu	lisovaná	
					index	lisovaná - hadice LW index
-06	-06	8,5	5/16	-	BU-52726-06-06-S	BU-53726-06-06-S
-08	-08	11,6	13/32	-	BU-52726-08-08-S	BU-53726-08-08-S
-10	-10	14,4	1/2	-	BU-52726-10-10-S	BU-53726-10-10-S
-12	-10	17,5	1/2	-	BU-52726-12-10-S	BU-53726-12-10-S
-12	-12	17,5	5/8	-	BU-52726-12-12-S	BU-53726-12-12-S

Koncovka ke kompresoru, s vnitřním závitem UNF

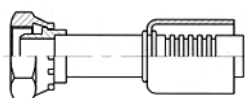

**52707**

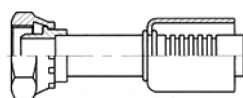

**53707**

modul přípojky	modul hadice	závit přípojky [cou]	vnitř. prům. hadice [cou]	rozměr ventilu	lisovaná	
					index	lisovaná - hadice LW index
-10	-08	1-14	13/32	-	BU-52707-10-08-S	BU-53707-10-08-S
-10	-10	1-14	1/2	-	BU-52707-10-10-S	BU-53707-10-10-S
-10	-12	1-14	5/8	-	BU-52707-10-12-S	BU-53707-10-12-S

Koncovka 45° ke kompresoru, s vnitřním závitem UNF

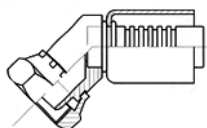

**52708**

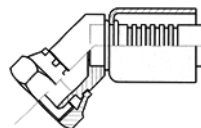

**53708**

modul přípojky	modul hadice	závit přípojky [cou]	vnitř. prům. hadice [cou]	rozměr ventilu	lisovaná	
					index	lisovaná - hadice LW index
-10	-08	1-14	13/32	-	BU-52708-10-08-S	BU-53708-10-08-S
-10	-10	1-14	1/2	-	BU-52708-10-10-S	BU-53708-10-10-S
-10	-12	1-14	5/8	-	BU-52708-10-12-S	BU-53708-10-12-S

# PRŮMYSLOVÉ HADICE - pro klimatizaci

## Koncovky pro pryžové klimatizační hadice

Koncovka 90° ke kompresoru, s vnitřním závitem UNF

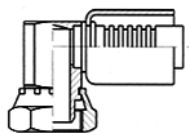

**52709**

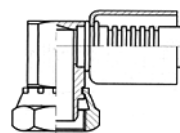

**53709**

modul přípojky	modul hadice	závit přípojky [coul]	vnitř. prům. hadice [coul]	rozměr ventilu	lisovaná	
					index	lisovaná - hadice LW index
-10	-08	1-14	13/32	-	BU-52709-10-08-S	BU-53709-10-08-S
-10	-10	1-14	1/2	-	BU-52709-10-10-S	BU-53709-10-10-S
-10	-12	1-14	5/8	-	BU-52709-10-12-S	BU-53709-10-12-S

Koncovka ke kompresoru, s vnitřním závitem UNF, s ventilem R134

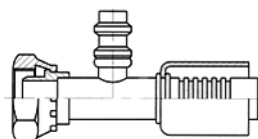

**52733**

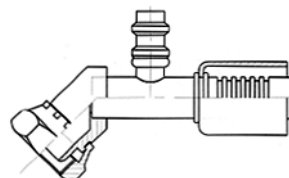

**52734**

modul přípojky	modul hadice	závit přípojky [coul]	vnitř. prům. hadice [coul]	rozměr ventilu [mm]	lisovaná	
					index	lisovaná 45° index
-10	-08	1-14	13/32	16	BU-52733-10-08-LP-S	BU-52734-10-08-LP-S
-10	-10	1-14	1/2	13	BU-52733-10-10-LP-S	BU-52734-10-10-LP-S
-10	-12	1-14	5/8	13	BU-52733-10-12-LP-S	BU-52734-10-12-LP-S

Koncovka 90° ke kompresoru, s vnitřním závitem UNF, s ventilem R134

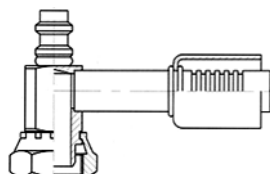

**52735**

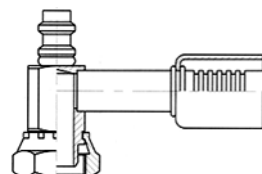

**53735**

modul přípojky	modul hadice	závit přípojky [coul]	vnitř. prům. hadice [coul]	rozměr ventilu [mm]	lisovaná	
					index	lisovaná - hadice LW index
-10	-08	1-14	13/32	16	BU-52735-10-08-LP-S	BU-53735-10-08-S
-10	-10	1-14	1/2	13	BU-52735-10-10-LP-S	BU-53735-10-10-S
-10	-12	1-14	5/8	13	BU-52735-10-12-LP-S	BU-53735-10-12-S



# PRŮMYSLOVÉ HADICE - pro klimatizaci

## Koncovky pro pryžové klimatizační hadice

Koncovka s vnějším závitem UNF, trubková

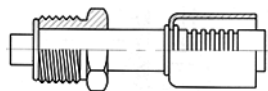

**52213**

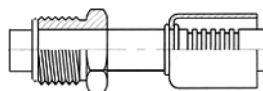

**53213**

modul přípojky	modul hadice	závit přípojky [coul]	vnitř. prům. hadice [coul]	rozměr ventilu	lisovaná	
					index	index
-06	-06	5/8-18	5/16	-	BU-52213-06-06-S	BU-53213-06-06-S
-08	-08	3/4-18	13/32	-	BU-52213-08-08-S	BU-53213-08-08-S
-10	-10	7/8-18	1/2	-	BU-52213-10-10-S	BU-53213-10-10-S
-10	-12	7/8-18	5/8	-	BU-52213-10-12-S	BU-53213-10-12-S
-12	-12	1.1/16-16	5/8	-	BU-52213-12-12-S	BU-53213-12-12-S

Koncovka 90° s vnějším závitem UNF, trubková

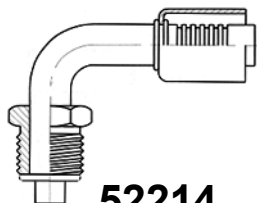

**52214**

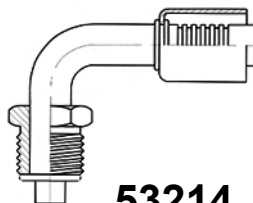

**53214**

modul přípojky	modul hadice	závit přípojky [coul]	vnitř. prům. hadice [coul]	rozměr ventilu	lisovaná	
					index	index
-06	-06	5/8-18	5/16	-	BU-52214-06-06-S	BU-53214-06-06-S
-08	-08	3/4-18	13/32	-	BU-52214-08-08-S	BU-53214-08-08-S
-10	-10	7/8-18	1/2	-	BU-52214-10-10-S	BU-53214-10-10-S
-12	-12	1.1/16-16	5/8	-	BU-52214-12-12-S	BU-53214-12-12-S

Koncovka 45° s vnějším závitem UNF, trubková

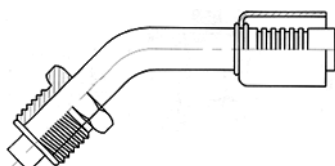

**52215**

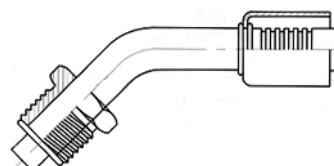

**53215**

modul přípojky	modul hadice	závit přípojky [coul]	vnitř. prům. hadice [coul]	rozměr ventilu	lisovaná	
					index	index
-06	-06	5/8-18	5/16	-	BU-52215-06-06-S	BU-53215-06-06-S
-08	-08	3/4-18	13/32	-	BU-52215-08-08-S	BU-53215-08-08-S
-10	-10	7/8-18	1/2	-	BU-52215-10-10-S	BU-53215-10-10-S
-10	-12	7/8-18	5/8	-	BU-52215-10-12-S	BU-53215-10-12-S
-12	-12	1.1/16-16	5/8	-	BU-52215-12-12-S	BU-53215-12-12-S

# PRŮMYSLOVÉ HADICE - pro klimatizaci

## Koncovky pro pryžové klimatizační hadice

Koncovka 90° s vnějším závitem UNF, trubková, s ventilem R134

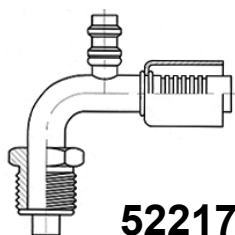

**52217**

modul přípojky	modul hadice	závit přípojky [coul]	vnitř. prům. hadice [coul]	rozměr ventilu [mm]	lisovaná	
					index	
-06	-06	5/8-18	5/16	16	BU-52217-06-06-HP-S	
-08	-08	3/4-18	13/32	16	BU-52217-08-08-HP-S	
-10	-10	7/8-18	1/2	13	BU-52217-10-10-LP-S	
-12	-12	1.1/16-16	5/8	13	BU-52217-12-12-LP-S	

Koncovka s vnějším závitem UNF, s otvorem

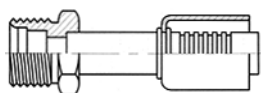

**52206**

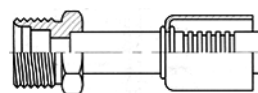

**53206**

modul přípojky	modul hadice	závit přípojky [coul]	vnitř. prům. hadice [coul]	rozměr ventilu	lisovaná	
					index	lisovaná - hadice LW index
-06	-06	5/8-18	5/16	-	BU-52206-06-06-S	BU-53206-06-06-S
-06	-08	5/8-18	13/32	-	BU-52206-06-08-S	BU-53206-06-08-S
-08	-08	3/4-16	13/32	-	BU-52206-08-08-S	BU-53206-08-08-S
-08	-10	3/4-16	1/2	-	BU-52206-08-10-S	BU-53206-08-10-S
-10	-08	7/8-14	13/32	-	BU-52206-10-08-S	BU-53206-10-08-S
-10	-10	7/8-14	1/2	-	BU-52206-10-10-S	BU-53206-10-10-S
-10	-12	7/8-14	5/8	-	BU-52206-10-12-S	BU-53206-10-12-S
-12	-12	1.1/16-14	5/8	-	BU-52206-12-12-S	BU-53206-12-12-S

Koncovka 45° s vnějším závitem UNF, s otvorem

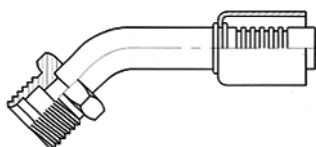

**52207**

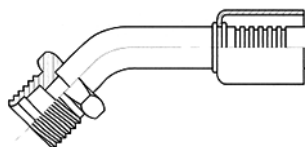

**53207**

modul přípojky	modul hadice	závit přípojky [coul]	vnitř. prům. hadice [coul]	rozměr ventilu	lisovaná	
					index	lisovaná - hadice LW index
-06	-06	5/8-18	5/16	-	BU-52207-06-06-S	BU-53207-06-06-S
-08	-08	3/4-16	13/32	-	BU-52207-08-08-S	BU-53207-08-08-S
-10	-10	7/8-14	1/2	-	BU-52207-10-10-S	BU-53207-10-10-S
-10	-12	7/8-14	5/8	-	BU-52207-10-12-S	BU-53207-10-12-S
-12	-12	1.1/16-14	5/8	-	BU-52207-12-12-S	BU-53207-12-12-S

# PRŮMYSLOVÉ HADICE - pro klimatizaci

## Koncovky pro pryžové klimatizační hadice

Koncovka 90° s vnějším závitem UNF, s otvorem

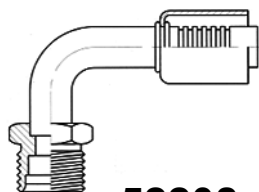

**52208**

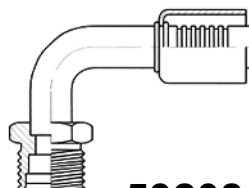

**53208**

modul přípojky	modul hadice	závit přípojky [coul]	vnitř. prům. hadice [coul]	rozměr ventilu	lisovaná	
					index	index
-06	-06	5/8-18	5/16	-	BU-52208-06-06-S	BU-53208-06-06-S
-08	-08	3/4-16	13/32	-	BU-52208-08-08-S	BU-53208-08-08-S
-10	-10	7/8-14	1/2	-	BU-52208-10-10-S	BU-53208-10-10-S
-10	-12	7/8-14	5/8	-	BU-52208-10-12-S	BU-53208-10-12-S
-12	-12	1.1/16-14	5/8	-	BU-52208-12-12-S	BU-53208-12-12-S

Koncovka přepážková s vnějším závitem UNF

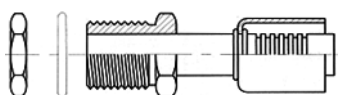

**52758**

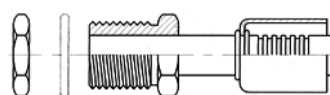

**53758**

modul přípojky	modul hadice	závit přípojky [coul]	vnitř. prům. hadice [coul]	rozměr ventilu	lisovaná	
					index	index
-06	-06	5/8-18	5/16	-	BU-52758-06-06-S	BU-53758-06-06-S
-08	-08	3/4-16	13/32	-	BU-52758-08-08-S	BU-53758-08-08-S
-10	-10	7/8-14	1/2	-	BU-52758-10-10-S	BU-53758-10-10-S
-12	-12	1.1/16-14	5/8	-	BU-52758-12-12-S	BU-53758-12-12-S

Koncovka přepážková s vnějším závitem UNF

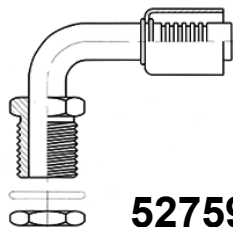

**52759**

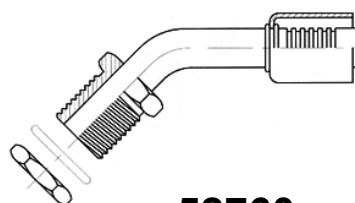

**52760**

modul přípojky	modul hadice	závit přípojky [coul]	vnitř. prům. hadice [coul]	rozměr ventilu	lisovaná	
					index	index
-06	-06	5/8-18	5/16	-	BU-52759-06-06-S	BU-52760-06-06-S
-08	-08	3/4-16	13/32	-	BU-52759-08-08-S	BU-52760-08-08-S
-08	-10	3/4-16	1/2	-	-	BU-52760-08-10-S
-10	-10	7/8-14	1/2	-	BU-52759-10-10-S	BU-52760-10-10-S
-10	-12	7/8-14	5/8	-	-	BU-52760-10-12-S
-12	-12	1.1/16-14	5/8	-	BU-52759-12-12-S	BU-52760-12-12-S

# PRŮMYSLOVÉ HADICE - pro klimatizaci

## Koncovky pro pryžové klimatizační hadice

Koncovka pro rychlospojku s vnějším závitem UNF

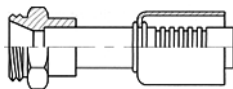

**53747**

modul přípojky	modul hadice	závit přípojky [coul]	vnitř. prům. hadice [coul]	rozměr ventilu	lisovaná - hadice LW	
					index	
-08	-06	7/8-20	5/16	-	BU-53747-08-06-S	
-12	-10	1.1/4-18	1/2	-	BU-53747-12-10-S	

Koncovka letovací

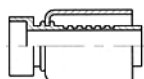

**52743**

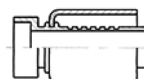

**53743**

modul přípojky	modul hadice	přípojka [coul]	vnitř. prům. hadice [coul]	rozměr ventilu	lisovaná	
					index	lisovaná - hadice LW index
-06	-06	3/8	5/16	-	BU-52743-06-06-S	BU-53743-06-06-S
-08	-08	1/2	13/32	-	BU-52743-08-08-S	BU-53743-08-08-S
-10	-10	5/8	1/2	-	BU-52743-10-10-S	BU-53743-10-10-S
-12	-12	3/4	5/8	-	BU-52743-12-12-S	BU-53743-12-12-S



koncovka před zalisováním



koncovka po zalisování

# PRŮMYSLOVÉ HADICE - pro klimatizaci

## Koncovky pro pryžové klimatizační hadice

Hadicová spojka s ventilem R12

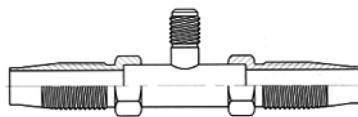

**7030 7025**

modul hadice 1	modul hadice 2	vnitř. prům. hadice 1 [coul]	vnitř. prům. hadice 2 [coul]	rozměr ventilu	šroubovaná	
					index	index
-06	-06	5/16	5/16	3/16	BU-7030-06-06-S	-
-06	-06	5/16	13/32	1/4	-	BU-7025-06-06-S
-08	-08	13/32	13/32	3/16	BU-7030-08-08-S	-
-08	-08	13/32	1/2	1/4	-	BU-7025-08-08-S
-10	-10	1/2	1/2	1/4	-	BU-7025-10-10-S
-12	-12	5/8	5/8	1/4	-	BU-7025-12-12-S

Hadicová spojka

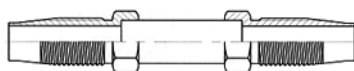

**7086**

modul hadice 1	modul hadice 2	vnitř. prům. hadice 1 [coul]	vnitř. prům. hadice 2 [coul]	rozměr ventilu	šroubovaná
					index
-06	-06	5/16	5/16	-	BU-7086-06-06-S
-08	-08	13/32	13/32	-	BU-7086-08-08-S
-10	-10	1/2	1/2	-	BU-7086-10-10-S
-12	-12	5/8	5/8	-	BU-7086-12-12-S

Montážní objímka

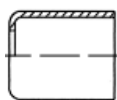

**2051**

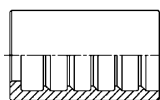

**2056**

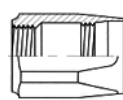

**1052**

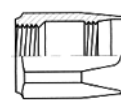

**115**

modul hadice	vnitř. prům. hadice [coul]	lisovaná hadice 3055	lisovaná hadice 3056	šroubovaná hadice 3055	šroubovaná hadice 3056
		index	index	index	index
-04	3/16	-	BU-2056-04-S	-	BU-115-04
-06	5/16	BU-2051-06	-	BU-1052-06	BU-115-06
-08	13/32	BU-2051-08	-	BU-1052-08	BU-115-08
-10	1/2	BU-2051-10	-	BU-1052-10	BU-115-10
-12	5/8	BU-2051-12	-	BU-1052-12	BU-115-12
-16	7/8	-	BU-2056-16-S	-	BU-115-16
-20	1. 1/8	-	BU-2056-20-S	-	BU-115-20
-24	1. 3/8	-	-	-	BU-115-24

# PRŮMYSLOVÉ HADICE - pro klimatizaci

## Koncovky pro pryžové klimatizační hadice

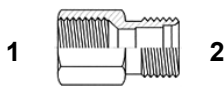
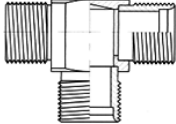
Adaptér UNF SAE 45° / UNF			T-kus 3 x UNF	
 <p style="text-align: center;"><b>7050</b></p>			 <p style="text-align: center;"><b>8048</b></p>	
index	rozměr závitu 1 [coul]	rozměr závitu 2 [coul]	index	rozměr závitu [coul]
BU-7050-06-06-S	5/8-18	5/8-18	BU-8048-06-06-S	5/8-18
BU-7050-08-08-S	3/4-16	3/4-16	BU-8048-08-08-S	3/4-16
BU-7050-08-10-S	3/4-16	7/8-14	BU-8048-10-10-S	7/8-14
BU-7050-10-10-S	7/8-14	7/8-14	BU-8048-12-12-S	1.1/16-14

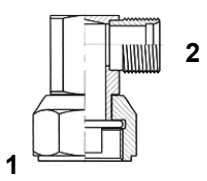
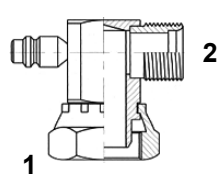
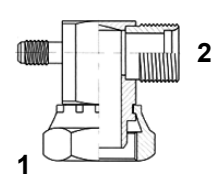
Adaptér 90° / UNF			Adaptér 90° / UNF s ventilem R134			Adaptér 90° / UNF s ventilem R12		
 <p style="text-align: center;"><b>7065</b></p>			 <p style="text-align: center;"><b>7066</b></p>			 <p style="text-align: center;"><b>7067</b></p>		
index	rozměr závitu 1 [coul]	rozměr závitu 2 [coul]	index	rozměr závitu 1 [coul]	rozměr závitu 2 [coul]	index	rozměr závitu 1 [coul]	rozměr závitu 2 [coul]
BU-7065-06-06-S	5/8-18	5/8-18	-	-	-	-	-	-
BU-7065-08-08-S	3/4-16	3/4-16	-	-	-	-	-	-
-	-	-	BU-7066-10-06-S	1-14	5/8-18	-	-	-
-	-	-	BU-7066-10-08-S	1-14	3/4-16	BU-7067-10-08-S	1-14	3/4-16
BU-7065-10-10-S	7/8-14	7/8-14	BU-7066-10-10-S	1-14	7/8-14	BU-7067-10-10-S	1-14	7/8-14

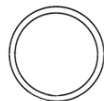
Adaptér R12/R134A - pojistné matice - ventil R134A					O-kroužek R12/R134A		
 <p style="text-align: center;"><b>7034/35/36    7037    7038    7039</b></p>					 <p style="text-align: center;"><b>7028</b></p>		
index	rozměr závitu [coul]	průměr D [mm]	index	pro adaptér	index	vnější průměr [mm]	síla [mm]
BU-7034-S	3/8-24	16	BU-7037	BU-7034-7036	BU-7028-06	7,65	1,78
BU-7035-S	7/16-20	13	BU-7038	BU-7035	BU-7028-08	10,82	1,78
BU-7036-S	7/16-20	16	BU-7039	BU-7035	BU-7028-10	14	1,78
-	-	-	-	-	BU-7028-12	17,17	1,78

# PRŮMYSLOVÉ HADICE - pro klimatizaci





## Rychlospojky pro klimatizaci

<b>Materiál:</b>	Galvanizovaná ocel
<b>Těsnění:</b>	CR (od -40°C do +120°C)
<b>Únik chladiva:</b>	1,5 g/rok
<b>Max. podtlak:</b>	2 mm Hg
<b>Koef. bezpečnosti:</b>	3:1 (statický tlak) 2:1 (dynamický tlak)

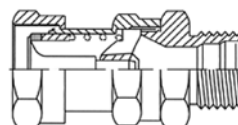
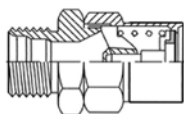
Oboustranně uzavíratelné, bezodkapové, šroubovací rychlospojky pro klimatizace a chladírenství. Používány pro plnění a vyprazdňování instalací (přečerpání chladiva). Spojka je vybavena kontra maticí, což umožňuje montáž na přepážku. Je možné spojovat spojku se zbytkovým tlakem (statický tlak, který zůstal v systému po vypnutí). Rychlospojky je možné rozpojovat při plném pracovním tlaku.



Spojka	index	rozměr	rozměr závitu	Vsuvka	index	rozměr	rozměr závitu
		BU-24421-06	1/4"		5/8"-18		BU-24422-06
	BU-24421-08	3/8"	3/4"-16		BU-24422-08	3/8"	3/4"-16
	BU-24421-10	1/2"	7/8"-14		BU-24422-10	1/2"	7/8"-14
	BU-24421-12	3/4"	1.1/16"-14		BU-24422-12	3/4"	1.1/16"-14

### Pracovní parametry:

rozměr	průnik vzduchu / úbytek tlaku (během spojování a rozpojování) [cm³]	pracovní tlak [bar]		
		spojená spojka	rozpojená spojka	rozpojená vsuvka
1/4"	0,02	330	175	35
3/8"	0,05	133	70	60
1/2"	0,1	183	183	50
3/4"	0,1	143	143	50